

PLAN REZ-DE-CHAUSSEE

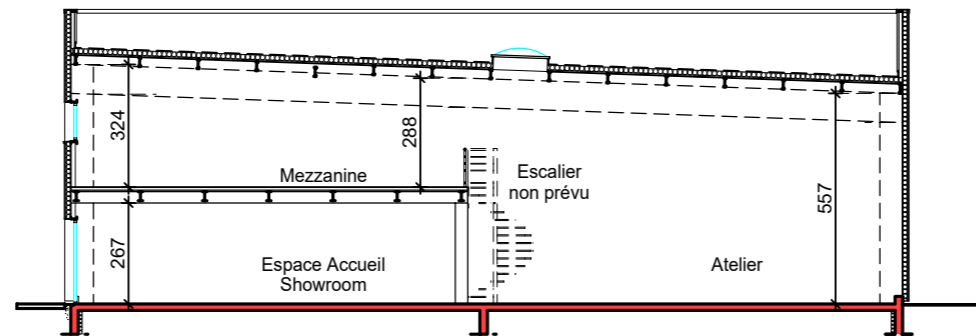

PLAN MEZZANINE

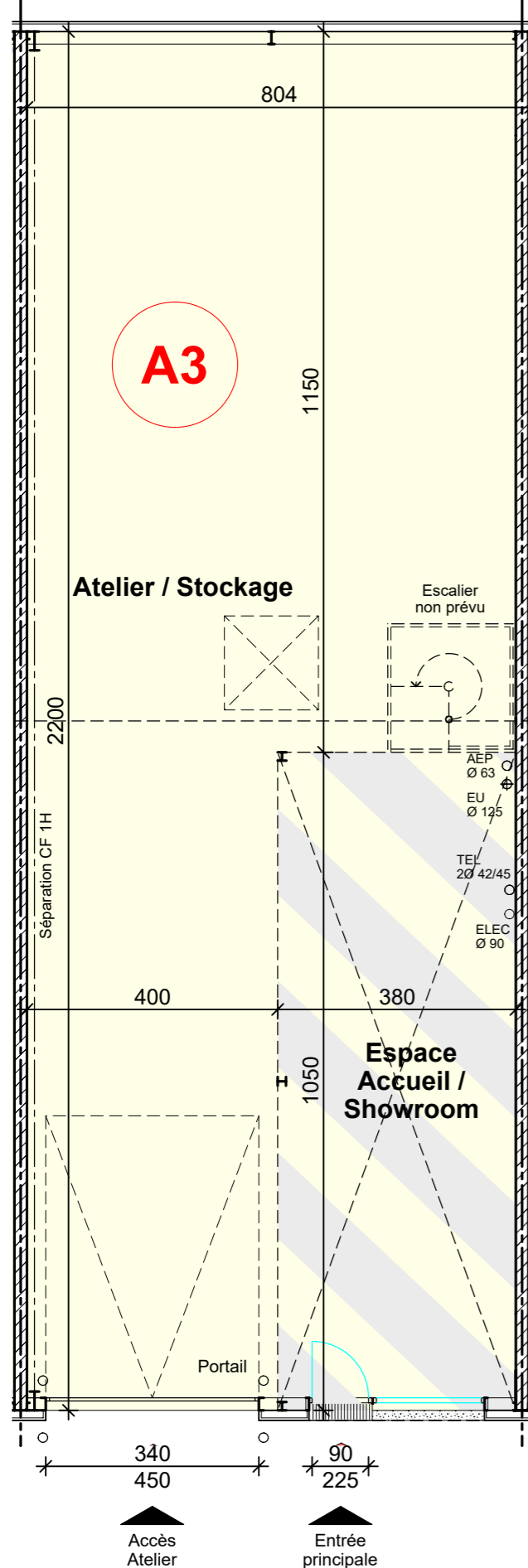
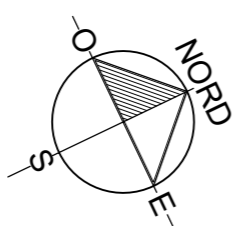
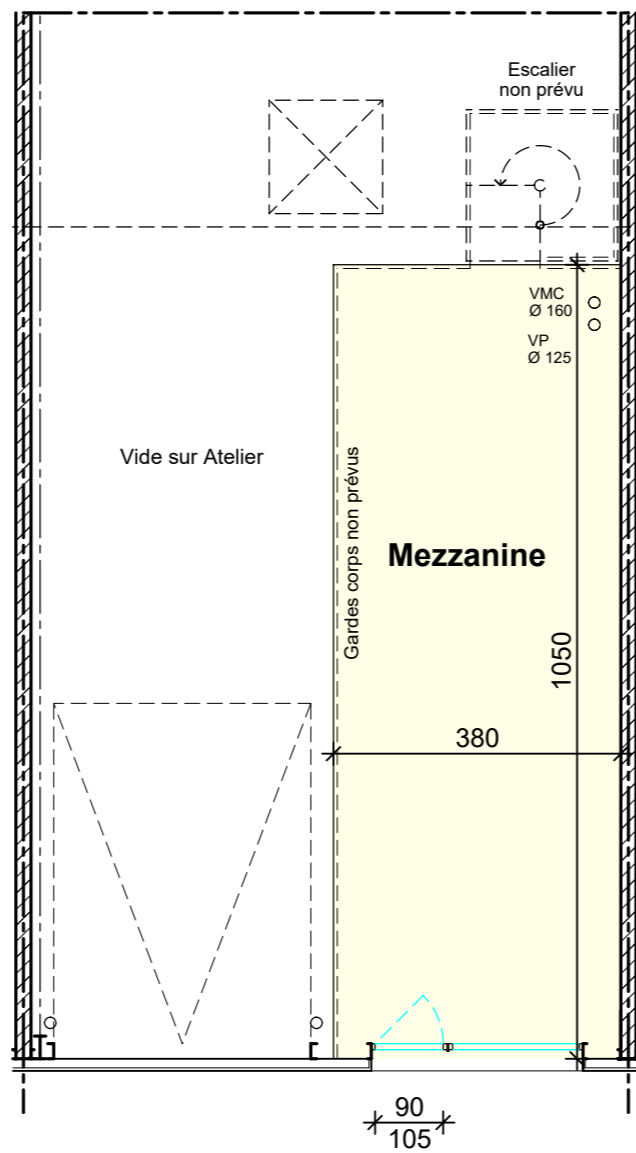

Echelle 50 | 1 m | 2 m | 5 m



Village d'ENTREPRISES

Z.A.C. de l'Abbaye

44160 PONTCHÂTEAU

Plan de Commercialisation

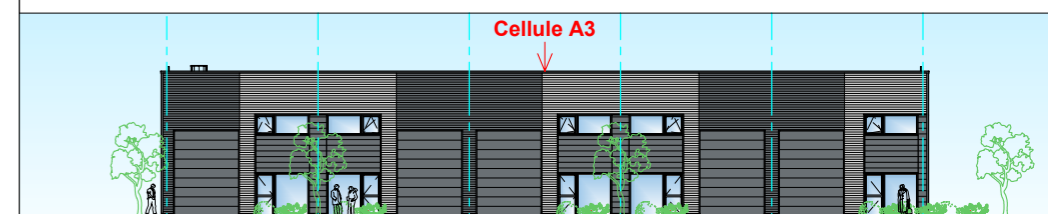
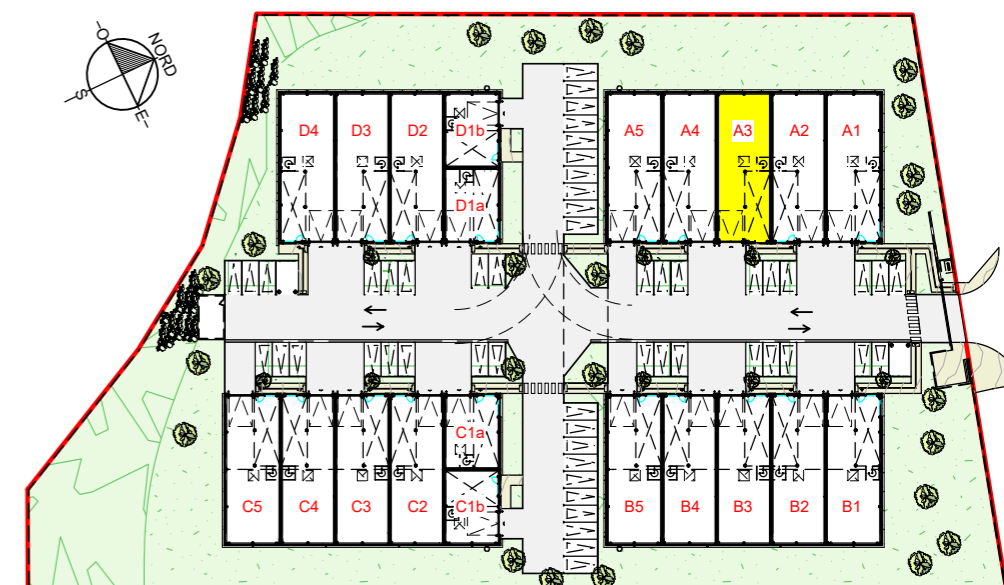

CELLULE

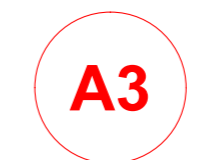

SURFACES COMMERCIALES UTILES

Atelier / Stockage
Espace Accueil / Showroom RdC 174.70 m²

Mezzanine 40.90 m²

TOTAL 215.60 m²

Plan réalisé le 04.11.2022

Modifié le :